

INTERIER BYTU V RD V BRNĚ / MOBILIÁŘ

Hlávkova, p.č.st. 1207, 602 00 Brno, č.p. 650, k.ú. Stránice klient: Martin Dedek

Půdorys 2NP

Ing. arch. Ivo Kratochvíl

A4

1:100

1

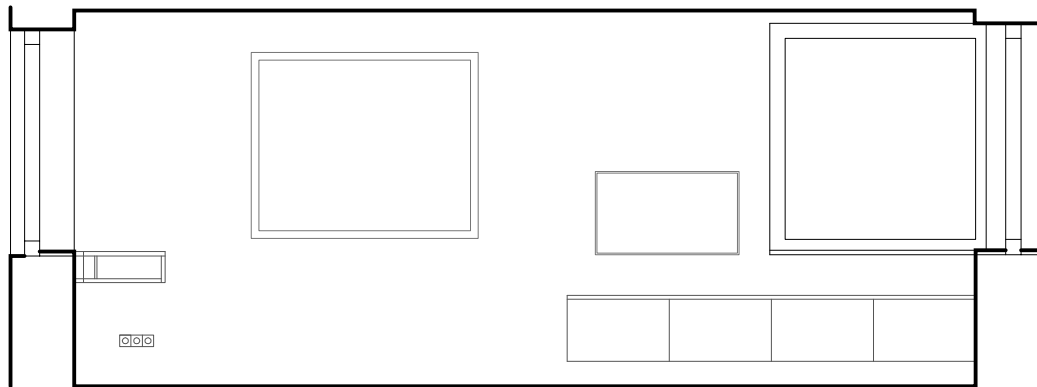

2700

435

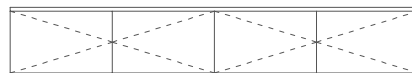

350

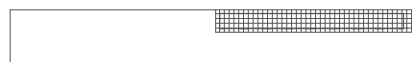

INTERIER BYTU V RD V BRNĚ / MOBILIÁŘ

Hlávkova, p.č.st. 1207, 602 00 Brno, č.p. 650, k.ú. Stránice

Skříňka k TV

Ing. arch. Ivo Kratochvíl A4

1:50

2

POHLED ZEPŘEDU

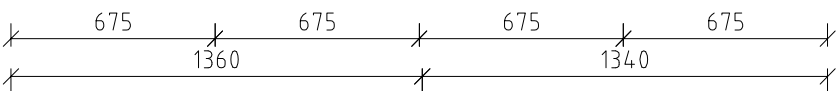
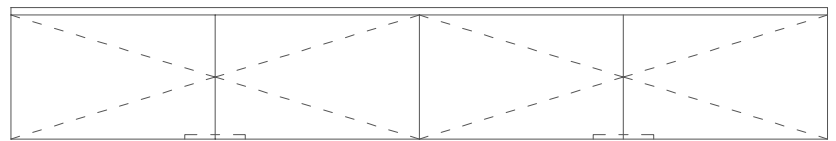

POHLED HORNÍ

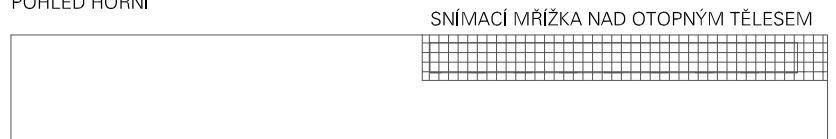

ŘEZ PODÉLNÝ

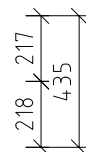
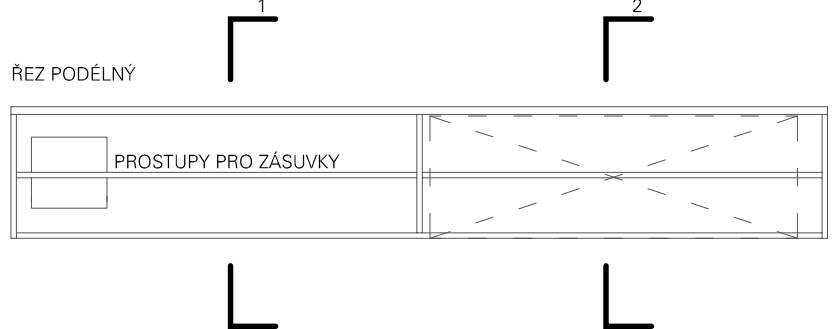

PŮDORYS

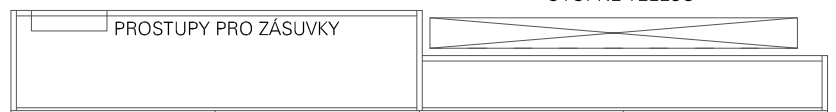

POHLED BOČNÍ

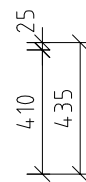
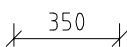

ŘEZ 1

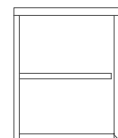

ŘEZ 2

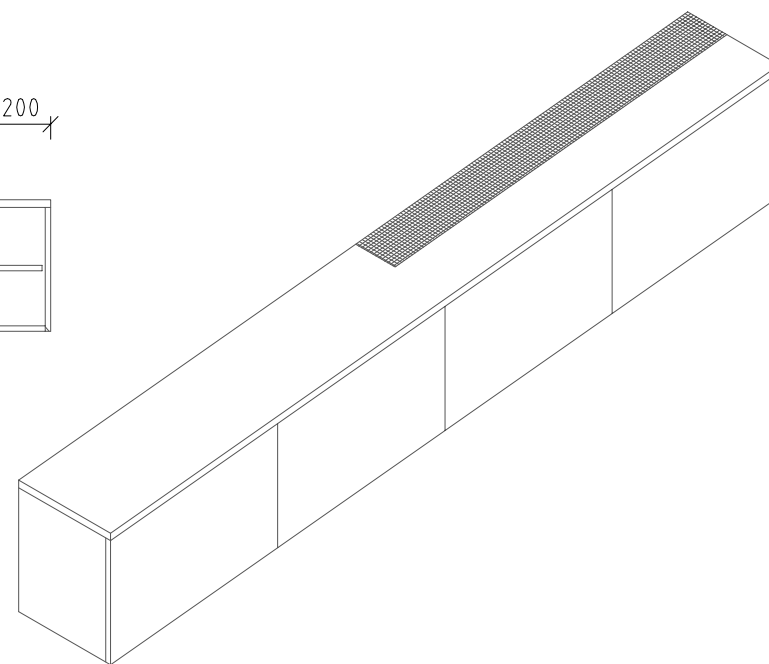

STAVEBNÍ PŘEKLIŽKA TL. 18mm - POVRCHOVÁ ÚPRAVA NÁTĚREM FERMEŽÍ

HORNÍ DESKA TL. 25mm

DVÍŘKA NA PANTECH - MADLA FRÉZOVANÉ DO SPODNÍ VNITŘNÍ HRANY

KRYCÍ MŘÍŽKA TOPENÍ Z ELOXOVANÉHO HLINÍKU, SNÍMATELNÁ

POLICE VÝŠKOVĚ STAVITELNÉ

SKŘÍŇKA KOTVENA DO ZDI

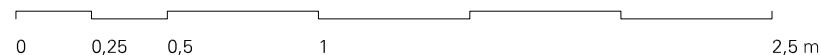

INTERIER BYTU V RD V BRNĚ / MOBILIÁŘ

Hlávkova, p.č.st. 1207, 602 00 Brno, č.p. 650, k.ú. Stránice klient: Martin Dedek

Skříňka k TV

Ing. arch. Ivo Kratochvíl A4 1:25 3